

**HSK
Spindel-
zubehör**

**Accessoires
de broche
HSK**

**HSK
spindle
accessories**

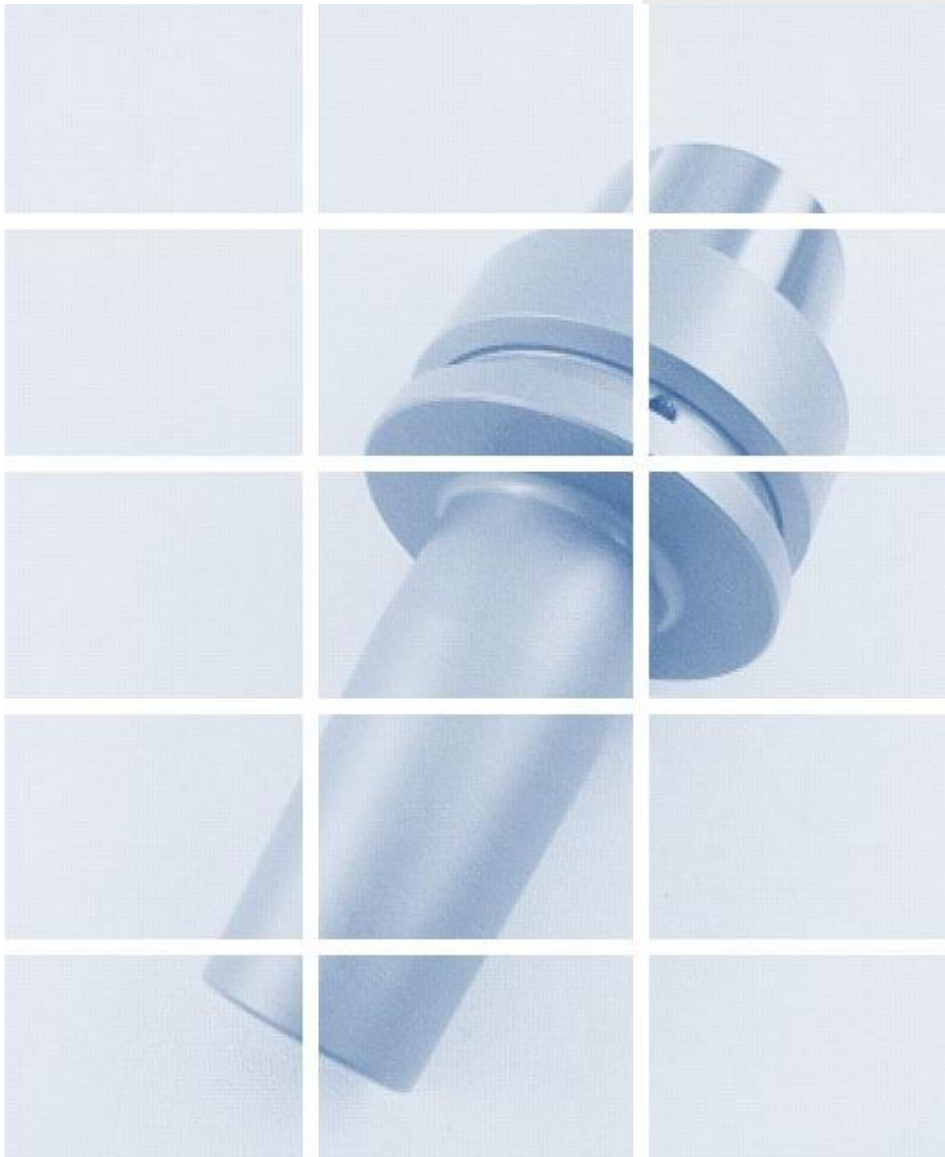

HSK-E40 / E50 / A63

FEHLMANN

DIN 69893

D

F

E

2

Wuchtgüte

Qualité d'équilibrage

Balancing quality

Verwenden Sie ausschliesslich Werkzeughalter mit einer Wuchtgüte G=2.5 bei Enddrehzahl der Arbeitsspindel. Detaillierte Informationen sind in der Bedienungs- und Wartungsanleitung Ihrer Maschine zu finden.

Utilisez uniquement des porte-outils possédant une qualité d'équilibrage de G=2.5 pour la vitesse finale de la broche de travail. Vous trouvez des informations détaillées dans le manuel d'emploi et de maintenance de votre machine.

Use exclusively tool holders with a balancing quality of G=2.5 at maximum speed of the working spindle. For detailed information please check the operating and maintenance manual of your machine.

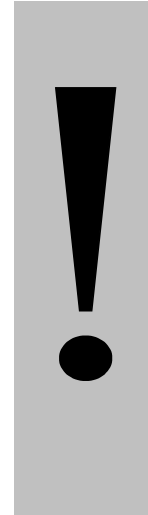

Inhaltsverzeichnis

Répertoire

Contents

HSK E40
DIN 69893

HSK E40
DIN 69893

HSK E40
DIN 69893

4 - 6

HSK E50
DIN 69893

HSK E50
DIN 69893

HSK E50
DIN 69893

7 - 10

HSK A63
DIN 69893

HSK A63
DIN 69893

HSK A63
DIN 69893

11 - 15

HSK Zubehör

Accessoires de HSK

HSK accessories

16 - 18

FEHLMANN AG, MASCHINENFABRIK, BIRREN 1, CH-5703 SEON / SWITZERLAND
TEL +41 62 769 11 11, FAX +41 62 769 11 90
mail@fehlmann.com www.fehlmann.com

D

F

E

3

Notizen

Notices

Notes

Blank area for notes, consisting of 20 horizontal grey lines.

HSK E40

DIN 69893

Wuchtgüte

Verwenden Sie ausschliesslich Werkzeughalter mit einer Wuchtgüte G=2.5 bei Enddrehzahl der Arbeitsspindel. Detaillierte Informationen sind in der Bedienungs- und Wartungsanleitung Ihrer Maschine zu finden.

Qualité d'équilibrage

Utilisez uniquement des porte-outils possédant une qualité d'équilibrage de G=2.5 pour la vitesse finale de la broche de travail. Vous trouvez des informations détaillées dans le manuel d'emploi et de maintenance de votre machine.

Balancing quality

Use exclusively tool holders with a balancing quality of G=2.5 at maximum speed of the working spindle. For detailed information please check the operating and maintenance manual of your machine.



D
F
E
5
Spindelzubehör
Accessoires de machines
Machine accessories
Bestell-Nr.
No. de commande
Order no
8411-060
**Spannzangenfutter
ER-ESX 16**
**Porte-pinces
ER-ESX 16**
**Collet chuck
ER-ESX 16**

 Spannbereich
0.5 - 10mm

 Gamme de serrage
0.5-10mm

 Clamping range
0.5 - 10mm

gewuchtet für 40'000 U/min

équilibré pour 40'000 tr/min

balanced for 40'000 rpm

 Spanschlüssel ER 16 -
Schlüsselweite 25 mm
(7219-025)

 Clé de serrage ER 16 -
ouverture 25 mm
(7219-025)

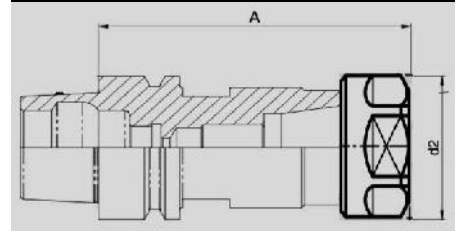
 Locking wrench ER 16 -
width 25 mm
(7219-025)

8411-060

8411-060

8411-060

 d2
28

 A
60

Bestell-Nr.
No. de commande
Order no
8437-031 / 8437-161
Schrumpfspannfutter
**Porte-fraises pour
frettage**
Shrink-fit millholder

gewuchtet für 42'000 U/min

équilibré pour 42'000 tr/min

balanced for 42'000 rpm

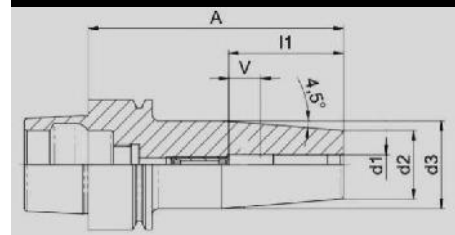

8437-031

8437-031

8437-031

d1

d2

d3

A

l1

V

8437-041

8437-041

8437-041

3

15

20

60

20

5

8437-061

8437-061

8437-061

4

15

20

60

20

5

8437-081

8437-081

8437-081

6

21

27

65

36

-

8437-101

8437-101

8437-101

8

21

27

65

36

-

8437-121

8437-121

8437-121

10

24

30

65

42

-

8437-161

8437-161

8437-161

12

24

32

90

42

10

8437-161

8437-161

8437-161

16

27

33

90

50

10

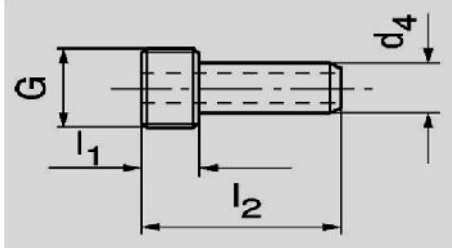
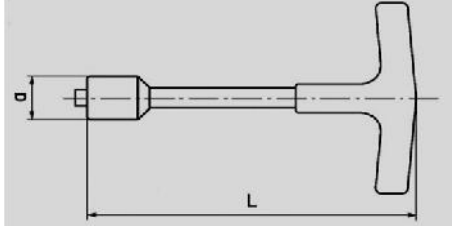
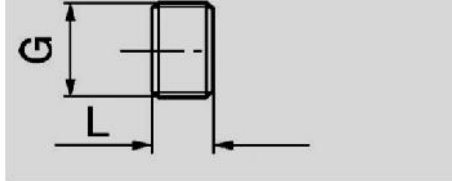
D	F	E									
Spindelzubehör	Accessoires de machines	Machine accessories									
Bestell-Nr.	No. de commande	Order no	8490-011								
Kühlmittel-übergaberohr	Raccord d'arrosage	Coolant fitting									
Spannschlüssel mitbestellen (8490-012)	Veillez commander une clé de serrage (8490-012)	Please order an appropriate key (8490-012)									
8490-011	8490-011	8490-011	<table border="1"> <tr> <td>G</td> <td>d₄</td> <td>l₁</td> <td>l₂</td> </tr> <tr> <td>M12 x 1</td> <td>8</td> <td>7.5</td> <td>29.2</td> </tr> </table>	G	d ₄	l ₁	l ₂	M12 x 1	8	7.5	29.2
G	d ₄	l ₁	l ₂								
M12 x 1	8	7.5	29.2								
Bestell-Nr.	No. de commande	Order no	8490-012								
Spannschlüssel zu Kühlmittel-übergaberohr	Clé de serrage pour raccord	Locking wrench for fitting									
			<table border="1"> <tr> <td>d</td> <td>L</td> </tr> <tr> <td>10.5</td> <td>112</td> </tr> </table>	d	L	10.5	112				
d	L										
10.5	112										
8490-012	8490-012	8490-012									
Bestell-Nr.	No. de commande	Order no	8490-013								
Verschlusszapfen zum Arbeiten ohne Innenkühlung	Tourillon de fermeture pour travailler sans arrosage par le centre	Screw plug to work without coolant trough centre									
Spannung mittels Innensechskant	Serrage par clé Jmbus	Clamping by Jmbus									
8490-013	8490-013	8490-013	<table border="1"> <tr> <td>G</td> <td>L</td> </tr> <tr> <td>M12 x 1</td> <td>7.5</td> </tr> </table>	G	L	M12 x 1	7.5				
G	L										
M12 x 1	7.5										

HSK E50

DIN 69893

Wuchtgüte

Verwenden Sie ausschliesslich Werkzeughalter mit einer Wuchtgüte G=2.5 bei Enddrehzahl der Arbeitsspindel. Detaillierte Informationen sind in der Bedienungs- und Wartungsanleitung Ihrer Maschine zu finden.

Qualité d'équilibrage

Utilisez uniquement des porte-outils possédant une qualité d'équilibrage de G=2.5 pour la vitesse finale de la broche de travail. Vous trouvez des informations détaillées dans le manuel d'emploi et de maintenance de votre machine.

Balancing quality

Use exclusively tool holders with a balancing quality of G=2.5 at maximum speed of the working spindle. For detailed information please check the operating and maintenance manual of your machine.

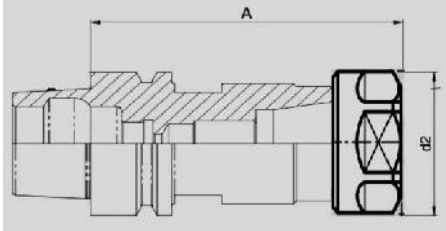

D	F	E
Spindelzubehör	Accessoires de machines	Machine accessories

Bestell-Nr.	No. de commande	Order no	8511-100
Spannzangenfutter ER-ESX 16	Porte-pinces ER-ESX 16	Collet chuck ER-ESX 16	
Spannbereich 0.5 - 10mm	Gamme de serrage 0.5-10mm	Clamping range 0.5 - 10mm	
gewuchtet für 36'000 U/min	équilibré pour 36'000 tr/min	balanced for 36'000 rpm	
Spannschlüssel ER 16 - Schlüsselweite 25 mm (7219-025)	Clé de serrage ER 16 - ouverture 25 mm (7219-025)	Locking wrench ER 16 - width 25 mm (7219-025)	
8511-100	8511-100	8511-100	d2 A 28 100

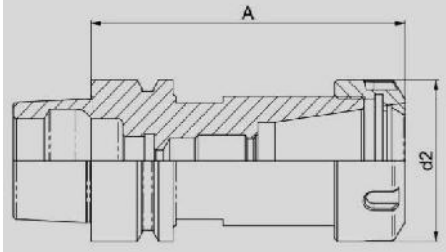
Bestell-Nr.	No. de commande	Order no	8513-080
Spannzangenfutter ER-ESX 25	Porte-pinces ER-ESX 25	Collet chucks ER-ESX 25	
Spannbereich 2 - 16mm	Gamme de serrage 2 - 16mm	Clamping range 2 - 16mm	
gewuchtet für 36'000 U/min	équilibré pour 36'000 tr/min	balanced for 36'000 rpm	
Spannschlüssel ER 25 (7218-025)	Clé de serrage ER 25 (7218-025)	Locking wrench ER 25 (7218-025)	
8513-080	8513-080	8513-080	d2 A 42 80

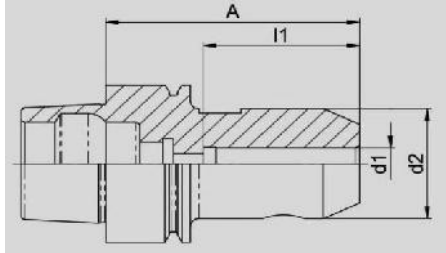
Bestell-Nr.	No. de commande	Order no	8530-106 / 8530-120
Spannfutter für Fräser mit zyl. Schaft und Spannfläche (Weldon)	Porte-fraises pour queue cylindrique et méplat (Weldon)	Chucks for milling cutters with straight shank and clamping flat (Weldon)	
gewuchtet für 15'000 U/min	équilibré pour 15'000 tr/min	balanced for 15'000 rpm	
8530-106	8530-106	8530-106	d1 d2 A l1
8530-108	8530-108	8530-108	6 25 65 37
8530-110	8530-110	8530-110	8 28 65 37
8530-112	8530-112	8530-112	10 35 65 41
8530-116	8530-116	8530-116	12 42 70 46
8530-116	8530-116	8530-116	16 48 75 49
8530-120	8530-120	8530-120	20 52 78 51

D	F	E
Spindelzubehör	Accessoires de machines	Machine accessories

Bestell-Nr.	No. de commande	Order no
Schrumpfspannfutter	Porte-fraises pour frettage	Shrink-fit millholder
gewuchtet für 42'000 U/min	équilibré pour 42'000 tr/min	balanced for 42'000 rpm

8537-031 / 8537-201

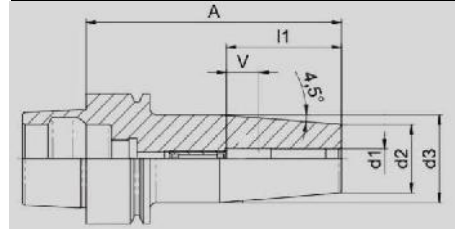

			d1	d2	d3	A	l1	V
8537-031	8537-031	8537-031	3	15	20	80	20	5
8537-041	8537-041	8537-041	4	15	20	80	20	5
8537-061	8537-061	8537-061	6	21	27	80	36	10
8537-081	8537-081	8537-081	8	21	27	80	36	10
8537-101	8537-101	8537-101	10	24	32	85	42	10
8537-121	8537-121	8537-121	12	24	32	90	47	10
8537-161	8537-161	8537-161	16	27	34	95	50	10
8537-201	8537-201	8537-201	20	33	42	100	52	10

Bestell-Nr.	No. de commande	Order no
Kombi-Aufsteckfräsdorn	Tasseau port-fraise universel	Universal milling arbor
gewuchtet für 15'000 U/min	équilibré pour 15'000 tr/min	balanced for 15'000 rpm

8540-016 / 8540-022 / 8540-027

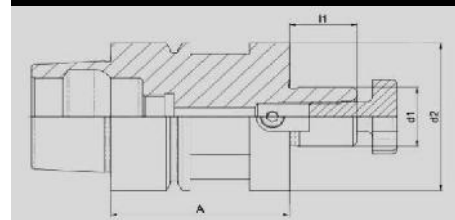

			d1	d2	A	l1
8540-016	8540-016	8540-016	16	42	45	17
8540-022	8540-022	8540-022	22	50	55	19
8540-027	8540-027	8540-027	27	50	58	21

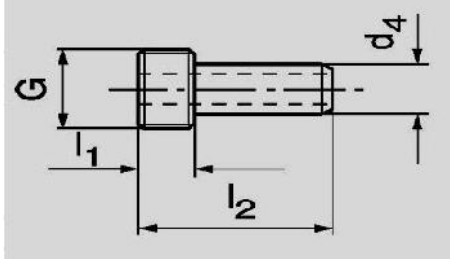
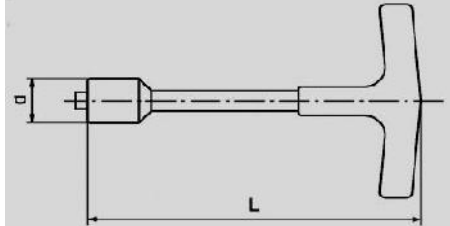
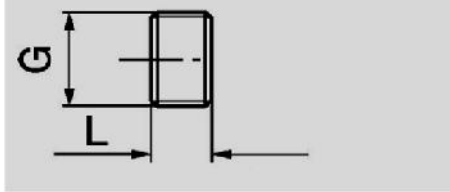
D	F	E									
Spindelzubehör	Accessoires de machines	Machine accessories									
Bestell-Nr.	No. de commande	Order no	8590-011								
Kühlmittel-übergaberohr	Raccord d'arrosage	Coolant fitting									
Spannschlüssel mitbestellen (8590-012)	Veillez commander une clé de serrage (8590-012)	Please order an appropriate key (8590-012)									
8590-011	8590-011	8590-011	<table border="1"> <tr> <td>G</td> <td>d₄</td> <td>l₁</td> <td>l₂</td> </tr> <tr> <td>M16 x 1</td> <td>10</td> <td>9.5</td> <td>32.7</td> </tr> </table>	G	d ₄	l ₁	l ₂	M16 x 1	10	9.5	32.7
G	d ₄	l ₁	l ₂								
M16 x 1	10	9.5	32.7								
Bestell-Nr.	No. de commande	Order no	8590-012								
Spannschlüssel zu Kühlmittel-übergaberohr	Clé de serrage pour raccord	Locking wrench for fitting									
8590-012	8590-012	8590-012	<table border="1"> <tr> <td>d</td> <td>L</td> </tr> <tr> <td>14.5</td> <td>117</td> </tr> </table>	d	L	14.5	117				
d	L										
14.5	117										
Bestell-Nr.	No. de commande	Order no	8590-013								
Verschlusszapfen zum Arbeiten ohne Innenkühlung	Tourillon de fermeture pour travailler sans arrosage par le centre	Screw plug to work without coolant trough centre									
Spannung mittels Innensechskant	Serrage par clé Jmbus	Clamping by Jmbus									
8590-013	8590-013	8590-013	<table border="1"> <tr> <td>G</td> <td>L</td> </tr> <tr> <td>M16 x 1</td> <td>9.5</td> </tr> </table>	G	L	M16 x 1	9.5				
G	L										
M16 x 1	9.5										

HSK A63

DIN 69893

Wuchtgüte

Verwenden Sie ausschliesslich Werkzeughalter mit einer Wuchtgüte G=2.5 bei Enddrehzahl der Arbeitsspindel. Detaillierte Informationen sind in der Bedienungs- und Wartungsanleitung Ihrer Maschine zu finden.

Qualité d'équilibrage

Utilisez uniquement des porte-outils possédant une qualité d'équilibrage de G=2.5 pour la vitesse finale de la broche de travail. Vous trouvez des informations détaillées dans le manuel d'emploi et de maintenance de votre machine.

Balancing quality

Use exclusively tool holders with a balancing quality of G=2.5 at maximum speed of the working spindle. For detailed information please check the operating and maintenance manual of your machine.

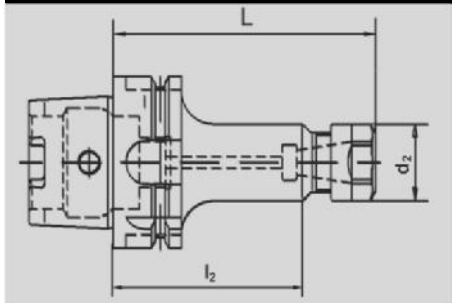
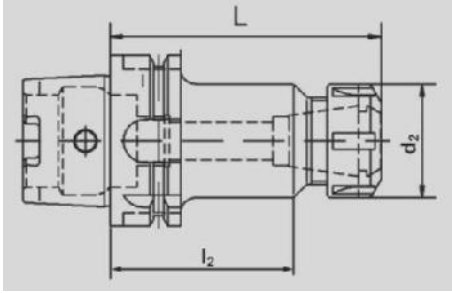
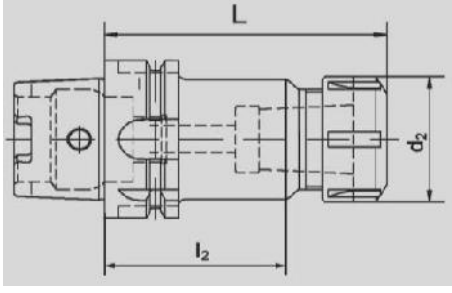

D	F	E									
Spindelzubehör	Accessoires de machines	Machine accessories									
Bestell-Nr.	No. de commande	Order no	8611-100								
Spannzangenfutter ER-ESX 16	Porte-pinces ER-ESX 16	Collet chucks ER-ESX 16									
Spannbereich 0.5 - 10mm	Gamme de serrage 0.5-10mm	Clamping range 0.5 - 10mm									
gewuchtet für 20'000 U/min	équilibré pour 20'000 tr/min	balanced for 20'000 rpm									
Spannschlüssel ER 16 - Schlüsselweite 25 mm (7219-025)	Clé de serrage ER 16 - ouverture 25 mm (7219-025)	Locking wrench ER 16 - width 25 mm (7219-025)									
8611-100	8611-100	8611-100	<table border="1"> <tr> <td>d₁</td> <td>d₂</td> <td>L</td> <td>l₂</td> </tr> <tr> <td>0.5-10</td> <td>25</td> <td>100</td> <td>60</td> </tr> </table>	d ₁	d ₂	L	l ₂	0.5-10	25	100	60
d ₁	d ₂	L	l ₂								
0.5-10	25	100	60								
Bestell-Nr.	No. de commande	Order no	8613-100								
Spannzangenfutter ER-ESX 25	Porte-pinces ER-ESX 25	Collet chucks ER-ESX 25									
Spannbereich 2 - 16mm	Gamme de serrage 2 - 16mm	Clamping range 2 - 16mm									
gewuchtet für 20'000 U/min	équilibré pour 20'000 tr/min	balanced for 20'000 rpm									
Spannschlüssel ER 25 (7218-025)	Clé de serrage ER 25 (7218-025)	Locking wrench ER 25 (7218-025)									
8613-100	8613-100	8613-100	<table border="1"> <tr> <td>d₁</td> <td>d₂</td> <td>L</td> <td>l₂</td> </tr> <tr> <td>0.5-16</td> <td>42</td> <td>80</td> <td>67</td> </tr> </table>	d ₁	d ₂	L	l ₂	0.5-16	42	80	67
d ₁	d ₂	L	l ₂								
0.5-16	42	80	67								
Bestell-Nr.	No. de commande	Order no	8614-100								
Spannzangenfutter ER-ESX 32	Porte-pinces ER-ESX 32	Collet chucks ER-ESX 32									
Spannbereich 3 - 20mm	Gamme de serrage 3 - 20mm	Clamping range 3 - 20mm									
gewuchtet für 20'000 U/min	équilibré pour 20'000 tr/min	balanced for 20'000 rpm									
Spannschlüssel ER 32 (7218-032)	Clé de serrage ER 32 (7218-032)	Locking wrench ER 32 (7218-032)									
8614-100	8614-100	8614-100	<table border="1"> <tr> <td>d₁</td> <td>d₂</td> <td>L</td> <td>l₂</td> </tr> <tr> <td>3 - 20</td> <td>50</td> <td>100</td> <td>67</td> </tr> </table>	d ₁	d ₂	L	l ₂	3 - 20	50	100	67
d ₁	d ₂	L	l ₂								
3 - 20	50	100	67								

D

F

E

Spindelzubehör

Accessoires de machines

Machine accessories

Bestell-Nr.

No. de commande

Order no

8630-006 / 8630-032

Spannfutter für Fräser mit zyl. Schaft und Spannfläche (Weldon)

gewuchtet für 10'000 U/min

Porte-fraises pour queue cylindrique et méplat (Weldon)

équilibré pour 10'000 tr/min

Chucks for milling cutters with straight shank and clamping flat (Weldon)

balanced for 10'000 rpm

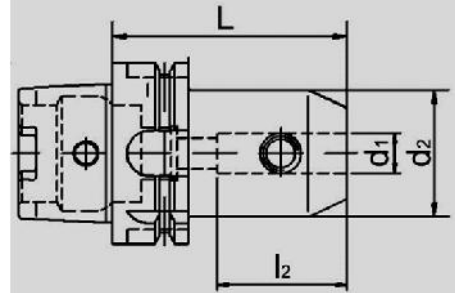

8630-006	8630-006	8630-006	d ₁	d ₂	L
8630-006	8630-006	8630-006	6	25	65
8630-008	8630-008	8630-008	8	28	65
8630-010	8630-010	8630-010	10	35	65
8630-012	8630-012	8630-012	12	42	80
8630-014	8630-014	8630-014	14	44	80
8630-016	8630-016	8630-016	16	48	80
8630-018	8630-018	8630-018	18	50	80
8630-020	8630-020	8630-020	20	52	80
8630-025	8630-025	8630-025	25	65	110
8630-032	8630-032	8630-032	32	72	110

Bestell-Nr.

No. de commande

Order no

8637-031 / 8637-201

Schrumpfspannfutter

gewuchtet für 24'000 U/min

Porte-fraise pour frettage

équilibré pour 24'000 tr/min

Shrink-fit millholder

balanced for 24'000 rpm

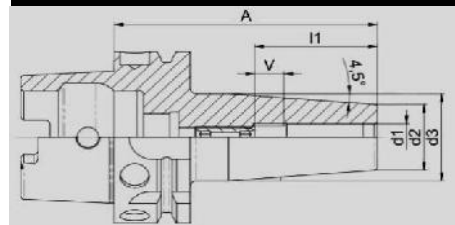

8637-031	8637-031	8637-031	d ₁	d ₂	d ₃	A	l ₁	V
8637-031	8637-031	8637-031	3	15	20	90	20	5
8637-041	8637-041	8637-041	4	15	20	90	20	5
8637-061	8637-061	8637-061	6	21	27	90	36	10
8637-081	8637-081	8637-081	8	21	27	90	36	10
8637-101	8637-101	8637-101	10	24	32	90	42	10
8637-121	8637-121	8637-121	12	24	32	90	47	10
8637-161	8637-161	8637-161	16	27	34	95	50	10
8637-201	8637-201	8637-201	20	33	42	100	52	10

D	F	E
Spindelzubehör	Accessoires de machines	Machine accessories

Bestell-Nr.	No. de commande	Order no
Kombi-Aufsteckfräsdorn	Tasseau port-fraise universel	Universal milling arbor
gewuchtet für 5'000 U/min	équilibré pour 5'000 tr/min	balanced for 5'000 rpm

8640-016 / 8640-032

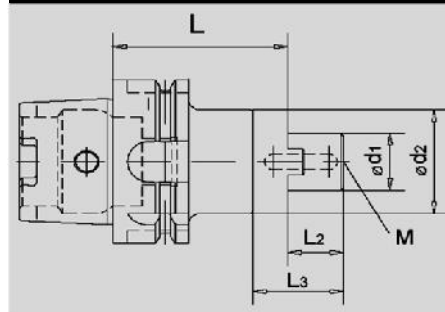

			d ₁	d ₂	M	L	L ₂	L ₃
8640-016	8640-016	8640-016	16	32	M8	60	17	27
8640-022	8640-022	8640-022	22	40	M10	60	19	31
8640-027	8640-027	8640-027	27	48	M12	60	21	33
8640-032	8640-032	8640-032	32	58	M16	60	24	38

Notizen	Notices	Notes

Technische Änderungen vorbehalten
 Sous réserve de modifications techniques
 Technical specifications subject to change

D

F

E

Spindelzubehör

Accessoires de machines

Machine accessories

Bestell-Nr.

No. de commande

Order no

8690-011

**Kühlmittel-
übergaberohr**

**Raccord pour
l'arrosage par le
centre**

**Fitting for coolant
trough the spindle**

Spannschlüssel
mitbestellen (8690-012)

Veillez commander une
clé de serrage (8690-012)

Please order an
appropriate key (8690-012)

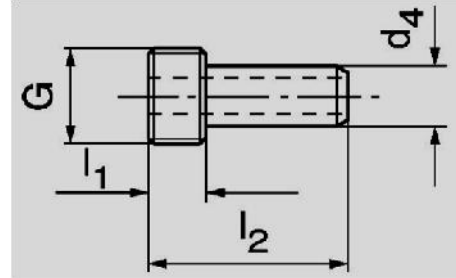

8690-011

8690-011

8690-011

G	d ₄	l ₁	l ₂
M18 x 1	10	9.5	32.7

Bestell-Nr.

No. de commande

Order no

8690-012

**Spannschlüssel zu
Kühlmittel-
übergaberohr**

**Clé de serrage pour
raccord**

**Locking wrench for
fitting**

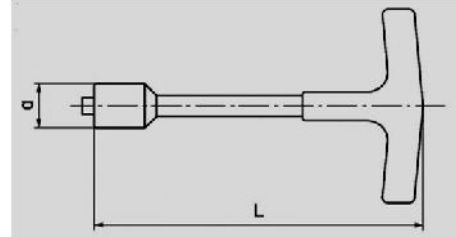

8690-012

8690-012

8690-012

d	L
16.5	122

Bestell-Nr.

No. de commande

Order no

8690-013

Verschlusszapfen
zum Arbeiten ohne
Innenkühlung

Tourillon de fermeture
pour travailler sans arrosage
par le centre

Screw plug
to work without coolant trough
centre

Spannung mittels
Innensechskant

Serrage par clé Jmbus

Clamping by Jmbus

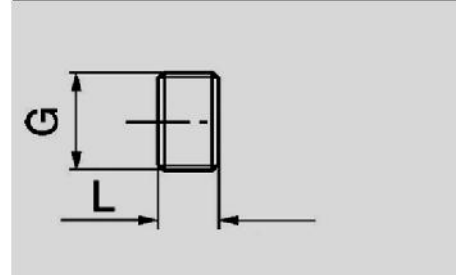

8690-013

8690-013

8690-013

G	L
M18 x 1	9.5

**HSK ZUBEHÖR
ACCESSOIRES DE HSK
HSK ACCESSORIES**

D	F	E	
Spindelzubehör	Accessoires de machines	Machine accessories	
Bestell-Nr.	No. de commande	Order no	8056-000
Werkzeugspannvorrichtung Tool Boy	Dispositif de serrage d'outils Tool Boy	Tool mounting device Tool Boy	
Grundgerät	Elément de base	Base element	
Adapter HSK-E40	Adaptation HSK-E40	Adapter HSK-E40	8056-140
Adapter HSK-E50	Adaptation HSK-E50	Adapter HSK-E50	8056-150
Adapter HSK-A63	Adaptation HSK-A63	Adapter HSK-A63	8056-160

Bestell-Nr.	No. de commande	Order no	8412- / 8425- / 8432-000
Spannzangen ER-UP (Ultra Präzision)	Pincos de serrage ER-UP (Ultra-Précision)	Collets ER-UP (Ultra-Precision)	
Nur Nenndurchmesser spannen	Serrage du d nominal seulement	To hold nominal d only	
ER 16-UP Satz a 10 Stk. 1-10mm steigend um 1mm	ER 16-UP Jeu de 10 pincos 1-10mm, pas de 1mm	ER 16-UP Set of 10 collets 1-10mm steps of 1mm	8412-001
ER 25-UP Satz a 15 Stk. 2-16mm steigend um 1mm	ER 25-UP Jeu de 15 pincos 2-16mm pas de 1mm	ER 25-UP Set of 15 collets 2-16mm steps of 1mm	8425-000
ER 32-UP Satz a 18 Stk. 3-20mm steigend um 1mm	ER 32-UP Jeu de 18 pincos 3-20mm pas de 1mm	ER 32-UP Set of 18 collets 3-20mm steps of 1mm	8432-000

Bestell-Nr.	No. de commande	Order no	7227- / 7221- / 7222-000
Spannzangen ER	Pincos de serrage ER	Collets ER	
Nur Nenndurchmesser spannen	Serrage du d nominal seulement	To hold nominal d only	
ER 16 Satz a 12 Stk. 1-2.5mm, steigend um 0.5mm. 3-10mm steigend um 1mm	ER 16 Jeu de 12 pincos 1-2.5mm, pas de 0.5mm. 3-10mm pas de 1mm.	ER 16 Set of 12 collets 1-2.5mm steps of 0.5mm. 3-10mm steps of 1mm.	7227-000
ER 25 Satz a 16 Stk. 2-2.5mm, steigend um 0.5mm. 3-16mm steigend um 1mm	ER 25 Jeu de 16 pincos 2-2.5mm, pas de 0.5mm. 3-16mm pas de 1mm.	ER 25 Set of 16 collets 2-2.5mm steps of 0.5mm. 3-16mm steps of 1mm.	7221-000
ER 32 Satz a 18 Stk. 3-20mm steigend um 1mm	ER 32 Jeu de 18 pincos 3-20mm pas de 1mm	ER 32 Set of 18 collets 3-20mm steps of 1mm	7222-000

D	F	E
Spindelzubehör	Accessoires de machines	Machine accessories

Bestell-Nr.	No. de commande	Order no	8401-000 / 8520-000 / 8620-000		
Konusreiniger HSK	Nettoyeur de cône HSK	Taper-wiper HSK			
8401-000	8401-000	8401-000	HSK 40		
8520-000	8520-000	8520-000	HSK 50		
8620-000	8620-000	8620-000	HSK 63		

Bestell-Nr.	No. de commande	Order no	8401-001/ 8520-001/ 8620-001		
Konusreiniger HSK zum Reinigen der Werkzeugaufnahmen	Nettoyeur de cône HSK pour nettoyer les portes- outils.	Taper-wiper HSK to clean tool holder			
8401-001	8401-001	8401-001	HSK 40		
8520-001	8520-001	8520-001	HSK 50		
8620-001	8620-001	8620-001	HSK 63		

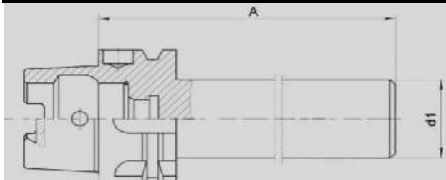
Bestell-Nr.	No. de commande	Order no	8482-100 / 8582-100 / 8682-100		
Kontrolldorn zur Rundlaufkontrolle der Spindel HSK	Cylindre de contrôle du battement de la broche HSK	Inspection cylinder to check the spindle roundness HSK			
Verschlusszapfen mitbestellen (8x90-013)	Veuillez commander le tourillon de fermeture (8x90-013)	Order screw plug (8x90-013)			
8482-100	8482-100	8482-100	HSK 40	d1 24	A 180
8582-100	8582-100	8582-100	HSK 50	32	236
8682-100	8682-100	8682-100	HSK 63	40	346

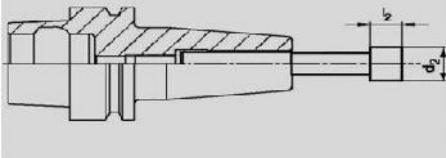
Bestell-Nr.	No. de commande	Order no	8079-004 / 8079-005 / 8079-006		
Nullwerkzeug	Outil de mise à zéro	Zero tool			
Zur raschen und wiederholt genauen Aufnahme einer Referenz-Oberfläche.	Pour la mesure rapide et précise d'une surface de référence.	For rapid and accurate measure of a reference surface.			
8079-004	8079-004	8079-004	HSK 40	d2 16	l2 10
8079-005	8079-005	8079-005	HSK 50	16	10
8079-006	8079-006	8079-006	HSK 63	16	10